

# 125A 4-pole and 5-pole up to 690 V

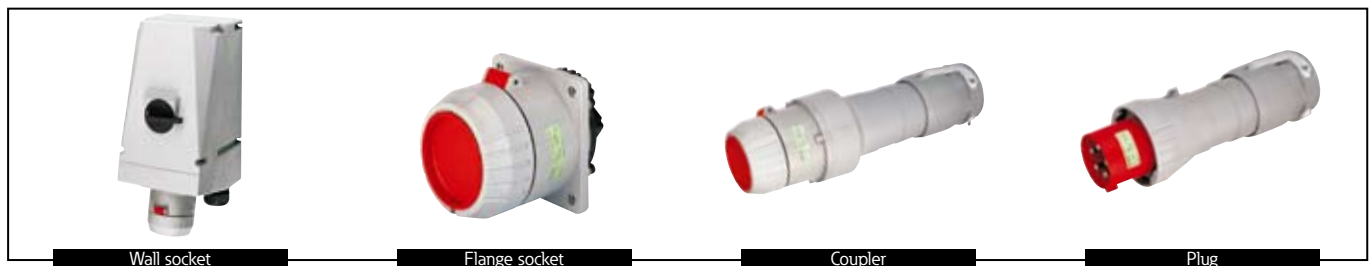

## Technical Data



Plugs and receptacles – Industry accd. to IEC 60309-1/2 up to 690 V	
Permissible ambient temperature	-20°C to +40°C / -40 °C to +40 °C (optional) <sup>1)</sup>
Rated voltage	690 V~
Rated current	125 A
Frequency	50/60 Hz
External back-up fuse, max.	without therm. protection: 125 A
Insulation class	I
Degree of protection to EN 60529	IP66
Wall socket with interlock switch	
Rated making/rated breaking capacity AC-23 accd. EN 60947 for wall socket with switch	Ue 500 V / Ie 70 A
Cable glands	1 x M63 Ø 27 - 48 mm, 1 x M63 thread plug plastic
Connecting terminals	2 x 10 – 70 mm <sup>2</sup>
Enclosure material	Glass-fibre reinforced polyester
Plug	
Cable glands	Ø 31 - 58 mm
Connecting terminals	1 x 2.5 – 35 mm <sup>2</sup>
Enclosure material	Polyamide
Coupler	
Cable glands	Ø 31 - 58 mm
Connecting terminals	1 x 16 – 35 mm <sup>2</sup>
Enclosure material	Polyamide
Flange socket	
Connecting terminals	1 x 2.5 – 35 mm <sup>2</sup>
Enclosure material	Polyamide

<sup>1)</sup> extended temperature range on request

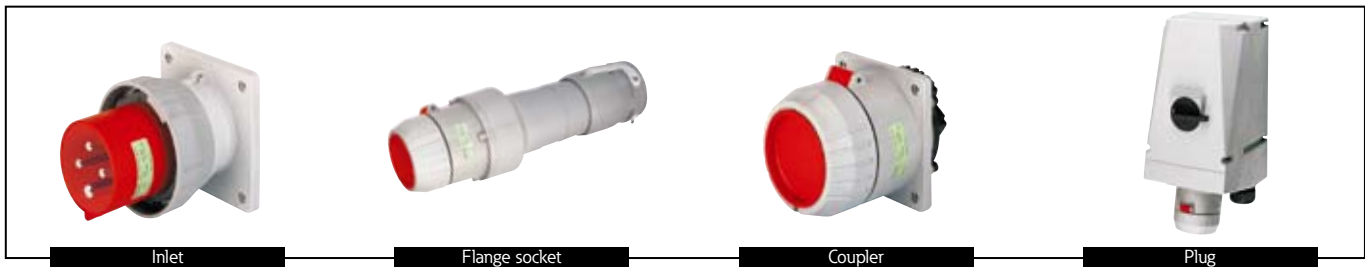
# 125A 4-pole and 5-pole up to 690 V

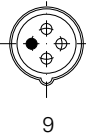
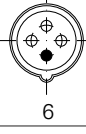
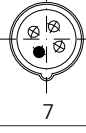
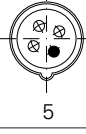

## Ordering Information

Voltage	h	Type	Weight approx.	Order No.
<b>Type 125 A 4-pole</b>				
200-250 V		Wall socket with interlock switch	8.6 kg	GHG 525 4409 R0001
		Plug	1.3 kg	GHG 525 7409 R0001
		Coupler	2.1 kg	GHG 525 3409 R0001
		Flange socket	1.4 kg	GHG 525 8409 R0001
		Inlet	0.9 kg	GHG 525 9409 R0001
380-415 V		Wall socket with interlock switch	8.6 kg	GHG 525 4406 R0001
		Plug	1.3 kg	GHG 525 7406 R0001
		Coupler	2.1 kg	GHG 525 3406 R0001
		Flange socket	1.4 kg	GHG 525 8406 R0001
		Inlet	0.9 kg	GHG 525 9406 R0001
480-500 V		Wall socket with interlock switch	8.6 kg	GHG 525 4407 R0001
		Plug	1.3 kg	GHG 525 7407 R0001
		Coupler	2.1 kg	GHG 525 3407 R0001
		Flange socket	1.4 kg	GHG 525 8407 R0001
		Inlet	0.9 kg	GHG 525 9407 R0001
600-690 V		Wall socket with interlock switch	8.6 kg	GHG 525 4405 R0001
		Plug	1.3 kg	GHG 525 7405 R0001
		Coupler	2.1 kg	GHG 525 3405 R0001
		Flange socket	1.4 kg	GHG 525 8405 R0001
		Inlet	0.9 kg	GHG 525 9405 R0001
<b>Type 125 A 5-pole</b>				
200-250 V		Wall socket with interlock switch	8.8 kg	GHG 525 4506 R0001
380-415 V		Plug	1.4 kg	GHG 525 7506 R0001
		Coupler	2.2 kg	GHG 525 3506 R0001
		Flange socket	1.5 kg	GHG 525 8506 R0001
		Inlet	1.1 kg	GHG 525 9506 R0001

Other voltage ranges and versions available on request

## Accessories

### Plug cap for plugs

Type	Order No.
Plug cap 4-pole/5-pole	GHG 510 1901 R0007

# 125A 4-pole and 5-pole up to 690 V

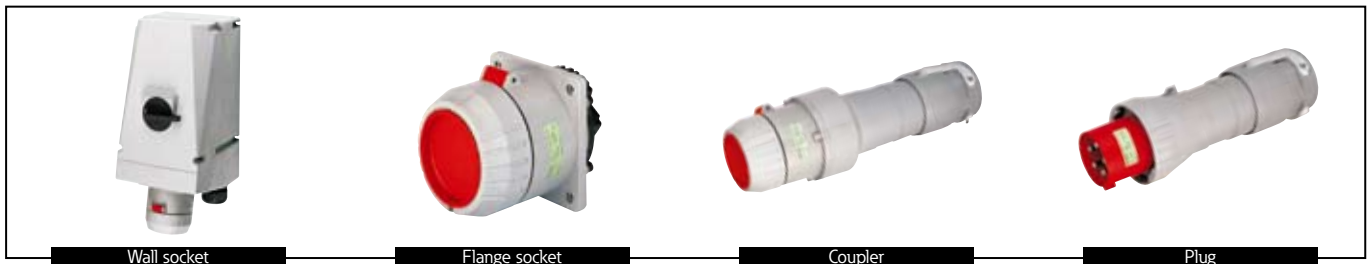

## Dimension Drawing | Wiring Diagram

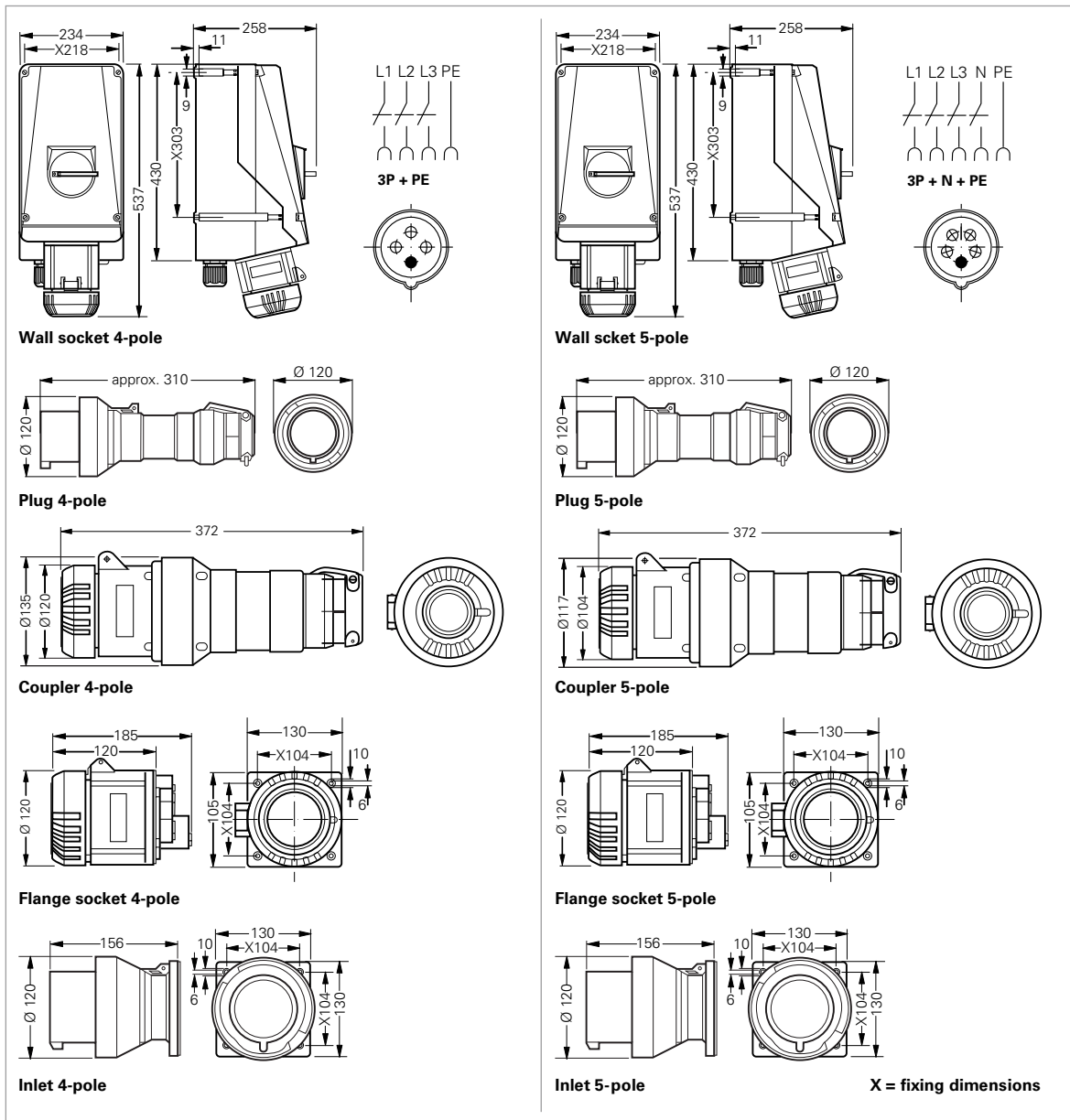

Dimensions in mm